

CATTLEMASTER 480

OVERALL DIMENSIONS

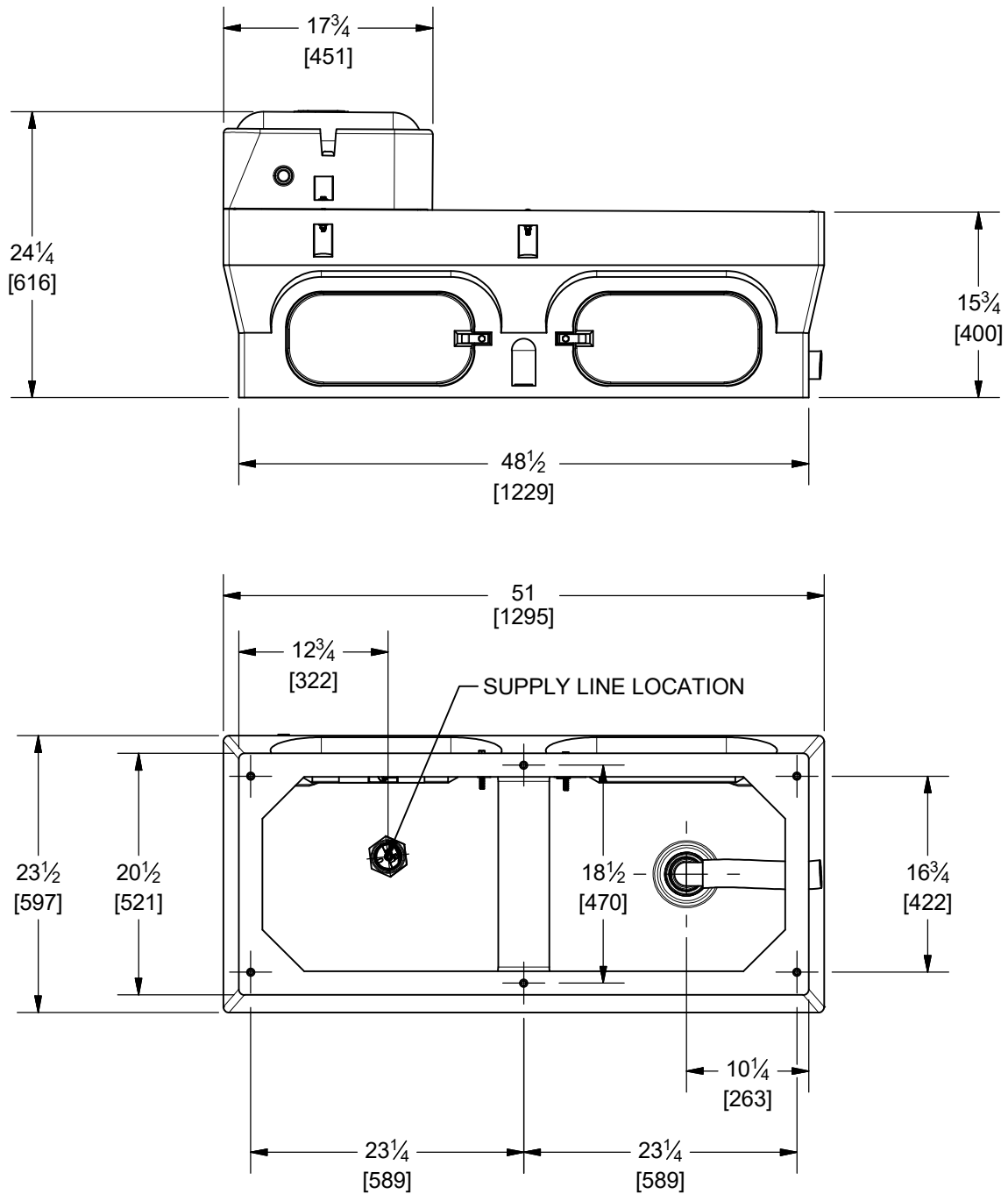

NOTE:

MOUNTING HOLE LOCATIONS ARE APPROXIMATE. DUE TO VARIATIONS IN MOLDING PROCESS, IT IS NOT RECOMMENDED TO USE THIS DRAWING FOR LOCATING CONCRETE ANCHORS. IT IS RECOMMENDED TO WAIT UNTIL UNIT IS AVAILABLE FOR MEASUREMENT.