

ELECTRICAL COMPONENTS

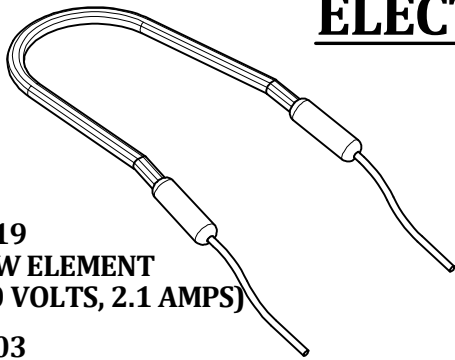

11419
250W ELEMENT
(120 VOLTS, 2.1 AMPS)

11403
300W ELEMENT
(240 VOLTS, 1.25AMPS)

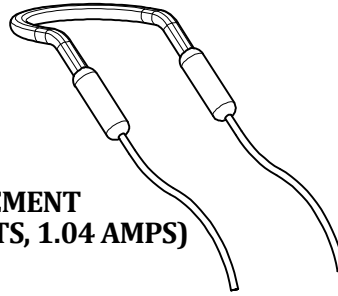

14150
125W ELEMENT
(120 VOLTS, 1.04 AMPS)

16664
200W ELEMENT
(240 VOLTS, 0.83AMPS)

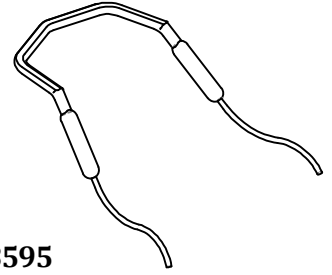

18595
125W ELEMENT
(Old Style)
(120 VOLTS, 1.04 AMPS)

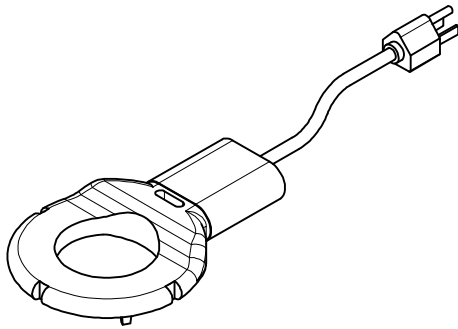

16311
250W IMMERSION HEATER
(120 VOLTS, 2.1 AMPS)

17960
250W IMMERSION HEATER
(240 VOLTS, 1.6AMPS)

17961
250W IMMERSION HEATER
(240 VOLTS, 1.6 AMPS)
EURO STYLE PLUG

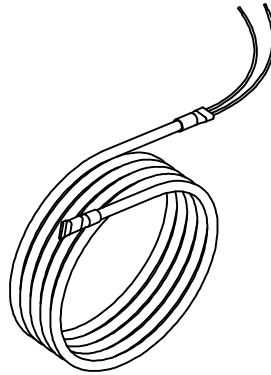

48W CABLE HEATER - 8FT
13830
(120 VOLTS, 0.4 AMPS)

16424
(240 VOLTS, 0.2AMPS)

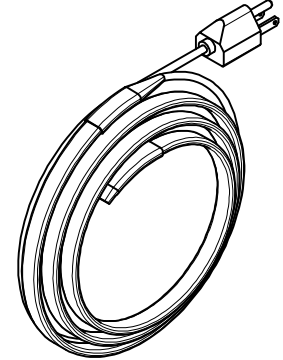

30W SELF LIMITING HEAT CABLE - 6FT
16276
(120 VOLTS, 0.25 AMPS)

16713
(240 VOLTS, 0.125AMPS)
NOTE: 120V INCLUDES 3 PRONG PLUG

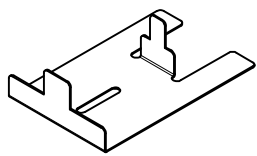

16636
IMMERSION HEATER
BRACKET STAND

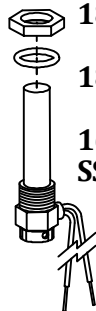

18074 - BRASS NUT PKG

18320 - O-RING PKG

16534
SS FENWAL T-STAT

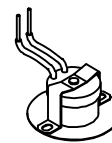

11885 DISC THERMOSTAT
(50 DEG - BLUE WIRE)

18679 DISC THERMOSTAT
(80 DEG - RED WIRE)

(120 VOLTS, 10 AMPS)
(240 VOLTS, 5 AMPS)

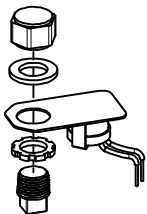

13680
KIT TO REPLACE
FENWAL PKG
(NOT RECOMENDED FOR UNITS
LARGER THAN 5'S)

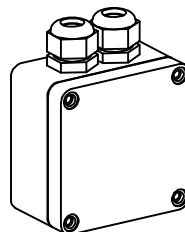

18787
JUNCTION BOX POLY PKG
18705
JUNCTION BOX POLY &
ADAPTER BRACKET PKG

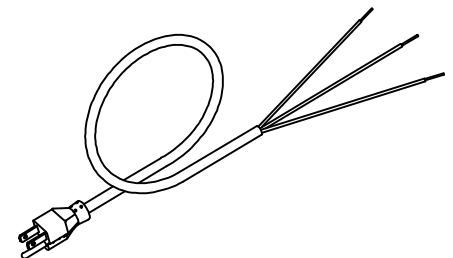

POWER CORD 18/3
18706 - (120 VOLTS)
18707 - (240 VOLTS)